

WEED EATER

® Trademark

ENGLISH



**Please do not return unit to retailer.
Por favor, no devuelva el aparato al lugar de compra.
Veuillez ne pas retourner l'outil au détaillant.**

1-800-554-6723

www.weedeater.com

Instruction Manual Manual de Instrucciones Manuel d'Instructions

EBV VS

**FOR HOUSEHOLD USE ONLY
PARA USO CASERO SOLAMENTE
POUR UTILISATION À DES FINS
DOMESTIQUES SEULEMENT**



ESPAÑOL



WARNING:

Read and follow all Safety Rules and Operating Instructions before using this product. Failure to do so can result in serious injury.

ADVERTENCIA:

Lea el manual de instrucciones y siga todas las advertencias e instrucciones de seguridad. El no hacerlo puede resultar en lesiones graves.

AVERTISSEMENT:

Veuillez lire le manuel d'instructions et bien respecter tous les avertissements et toutes les instructions de sécurité. Tout défaut de le faire pourrait entraîner des blessures graves.

WEED EATER
1030 Stevens Creek Road
Augusta, GA 30907

WEED EATER
5855 Terry Fox Way
Mississauga, Ontario L5V 3E4

FRANÇAIS

545117528 8/8/06

IMPORTANT WARNINGS AND SAFETY INSTRUCTIONS

WARNING:

When using electric gardening appliances, basic safety precautions should always be followed to reduce the risk of fire, electric shock, and serious injury. The warnings and safety instructions in this manual must be followed to reduce the risk of fire, electric shock, or injury, and to provide reasonable safety and efficiency in using this unit. The operator is responsible for following the warnings and instructions in this manual and on the unit. Read the entire instruction manual before assembling and using the unit! Restrict the use of this unit to persons who read, understand, and follow the warnings and instructions in this manual and on the unit. Never allow children to use this unit. Do not allow the unit to be used as a toy. Close attention is necessary when used near children. Always disconnect unit from power source before servicing, cleaning, performing maintenance, or storing. Nonconforming replacement components or the removal of safety devices may cause damage to the unit and possible injury to the operator or bystanders. Use only accessories and replacement parts as recommended. Use only for jobs explained in this manual.

OPERATOR SAFETY

- Always wear safety glasses or similar eye protection when operating, servicing, or performing maintenance on your unit. Wearing eye protection can help to prevent rocks or debris from being blown or ricocheting into eyes and face which can result in blindness or serious injury.
- Always wear a respirator or face mask when working with the unit in dusty environments.
- Dress safely in long pants. Do not go barefoot or wear short pants or sandals.
- Do not operate the unit when you are tired, ill, upset, or if you are under the influence of alcohol, drugs, or medication.
- Secure hair so it is above shoulder length. Keep loose hair, loose clothing, fingers, and all other parts of the body away from openings and moving parts. Hair, jewelry, loose clothing, or clothing with loosely hanging straps, ties, tassels, etc., can be caught in moving parts.

ELECTRICAL SAFETY

WARNING:

Avoid a dangerous environment. To reduce the risk of electrical shock, do not use in rain, in damp or wet locations, or around swimming pools, hot tubs, etc. Do not expose to snow, rain, or water to avoid the possibility of electrical shock. Do not use on wet surfaces. Do not handle extension cord plug or unit with wet hands. Avoid dangerous situations. Do not use in the presence of flammable liquids or

gases to avoid creating a fire or explosion and/or causing damage to unit. Do not abuse cord. Never carry the unit by the extension cord or yank extension cord to disconnect unit. To unplug, grasp the plug, not the cord. Do not use cord as a handle, close a door on cord, or pull cord around sharp edges or corners. Turn off all controls before unplugging. Do not expose cords to heat, oil, or water. Do not use with damaged cord or plug. If unit is not working as it should, has been dropped, damaged, left outdoors, or dropped into water, return it to your authorized service dealer for repair. Unplug the unit from the power source when not in use, before servicing, cleaning, performing maintenance, or storing. Do not put any object into openings. Do not use with any opening blocked; keep free of dust, lint, hair and anything that may reduce air flow.

- Use only a voltage supply as shown on the nameplate of the unit.
- Avoid dangerous environments. Do not use in unventilated areas or where dust or explosive vapors can build up.
- To reduce the risk of electrical shock, this unit has a polarized plug (one blade is wider than the other) and will require the use of a polarized extension cord. The appliance plug will fit into a polarized extension cord only one way. If the plug does not fit fully into the extension cord, reverse the plug. If the plug still does not fit, obtain a correct polarized extension cord. A polarized extension cord will require the use of a polarized wall outlet. This plug will fit into the polarized wall out-

let only one way. If plug does not fit fully into the wall outlet, reverse the plug. If it still does not fit, contact a qualified electrician to install the proper wall outlet. Do not change the equipment plug, extension cord receptacle, or extension cord plug in any way.

- To reduce the risk of electrical shock, use extension cords specifically marked as suitable for outdoor appliances. The electrical rating of the cord must not be less than the rating of the unit. The cord must be marked with the suffix "W-A" (in Canada, "W"). Make sure your extension cord is in good condition. Inspect extension cord before use and replace if damaged. An undersized extension cord will cause a drop in line voltage resulting in loss of power and overheating. If in doubt, use the next heavier gauge. The smaller the gauge number, the heavier the cord. (**NOTE:** The correct size to be used depending on the cord length is shown in this manual. See SELECT AN EXTENSION CORD in the ASSEMBLY section).
- Do not use multiple cords.
- Keep the extension cord clear of operator and obstacles at all times.
- Tie cord to cord retainer and connect to recessed plug as shown in this manual to prevent damage to unit and/or extension cord and to reduce the possibility of the extension cord disconnecting from the unit during operation.
- Do not attempt to repair unit. Inspect the insulation and connectors on the unit and extension cord before each use. If there is any damage, do not use until damage is repaired by your authorized service dealer.
- Do not use the unit if the switch does not turn the unit on and off properly. Have the unit repaired by your authorized service dealer.
- Avoid accidental starting. Be sure the switch is in the OFF position and keep your hand and fingers away from the switch while connecting the unit to the power source or when carrying a unit connected to the power source.
- Avoid any body contact with any grounded conductor, such as metal fences, or pipes, to avoid the possibility of electric shock.
- Ground Fault Circuit Interrupter (GFCI) protection should be provided on the circuit or outlet to be used for this unit. Receptacles are available having built-in GFCI protection and may be used for this measure of safety.
- Stop the motor immediately if you are approached.

DOUBLE INSULATION CONSTRUCTION

This unit is double insulated to help protect against electric shock. Double insulation construction consists of two separate "layers" of electrical insulation instead of grounding. Tools and appliances built with a double insulation system are not intended to be grounded. No grounding means is provided on this unit, nor should a means of grounding be added to this unit. As a result, the extension cord used with your unit can be plugged into any standard 120 volt electrical outlet. Safety precautions must be observed when operating any electrical tool. The double insulation system only provides added protection against injury resulting from an internal electrical insulation failure.

⚠ WARNING:

All electrical repairs to this unit, including housing, switch, motor, etc., must be diagnosed and repaired by qualified service personnel. Replacement parts for a double insulated appliance must be identical to the parts they replace. A double insulated appliance is marked with the words "double insulation" or "double insulated". The symbol  (square within a square) may also be marked on the appliance. Failure to have the unit repaired by an authorized service dealer can cause the double insulation construction to become ineffective and result in serious injury.

UNIT/MAINTENANCE SAFETY

- Do not set the unit on any surface except a clean, hard area while the unit is running. Debris such as gravel, sand, dust, grass, etc., could be picked up by the air intake and thrown out through the discharge opening, damaging the unit, property, or causing serious injury to bystanders or operator.
- Do not overreach or use from unstable surfaces such as ladders, trees, steep slopes, rooftops, etc. Use extra care when cleaning on stairways. Keep firm footing and balance at all times. Keep hands out of tubes.
- Inspect the entire unit before each use for worn, loose, missing, or damaged parts. Do not use until the unit is in proper working order.
- This unit is double insulated. See the DOUBLE INSULATION CONSTRUCTION section. Have all internal service performed by qualified service repair personnel to avoid creating a hazard or voiding your warranty.

- Have all maintenance other than the recommended procedures described in the instruction manual performed by your authorized service dealer.
- Always see your authorized service dealer to replace a damaged impeller. Parts that are chipped, cracked, broken, or damaged in any other way can fly apart and cause serious injury. Replace damaged parts before using the unit.
- Never place any object in the air intake opening as this could restrict proper air flow and cause damage to the unit.
- Never douse the unit with water or other liquids or squirt with a water hose. Clean the unit using a damp cloth. Wipe off with a clean dry cloth. See MAINTENANCE.
- Check air intake openings and tubes frequently, always with the unit stopped and power source disconnected. Keep vents and tubes free of debris which can accumulate and restrict proper air flow.
- Do not burn, incinerate, or expose this unit to extreme heat.
- Store the unit unplugged in a high, cool, dry, indoor area out of the reach of children.
- Use only recommended attachments and replacement parts to avoid creating a hazard and/or voiding warranty.
- Maintain the unit according to recommended procedures.
- Use only for jobs explained in the OPERATION section of this manual.

BLOWER SAFETY

- Use only in daylight or in good artificial light.
- Inspect the area before using the unit. Remove all debris and hard objects such as rocks, glass, wire, etc., that can ricochet, be thrown, or otherwise cause injury or damage during operation.
- Never run the unit without the proper equipment attached. When used as a blower, always install a blower tube. Use only recommended attachments.
- To avoid spreading fire, do not use blower near leaf or brush fires, fireplaces, barbecue pits, ashtrays, etc.
- Never place objects inside the blower tubes; always direct the blowing debris away from people, animals, glass, and solid objects such as trees, automobiles, walls, etc. The force of air can cause rocks, dirt, or sticks to be thrown or to ricochet which can hurt people or animals, break glass, or cause other damage.
- Never use for spreading chemicals, fertilizers, or any other substances which may contain toxic materials.

VACUUM SAFETY

- Stop the motor and disconnect the power source before opening the air inlet door or attempting to insert or remove the vacuum tubes. The motor must be stopped and the impeller blades no longer turning to avoid serious injury from the rotating blades.
- Hard objects can be thrown through the collection bag or the housing and become dangerous missiles which can cause serious injury to the operator or others.
- When using the vacuum attachment, the unit is designed to pick up dry material such as leaves, grass, small twigs, and bits of paper. Do not vacuum stones, gravel, metal, broken glass, etc., to avoid severe damage to the impeller. To avoid the possibility of electrical shock, do not attempt to vacuum water or other liquids.
- Never run the unit without the proper equipment attached. When used as a vacuum, always install vacuum tubes and collection bag assembly. Make sure the collection bag assembly is completely zipped when unit is running to avoid flying debris. Use only recommended attachments.
- Avoid situations which could set the collection bag on fire. Do not vacuum discarded matches, cigars, cigarettes, or ash from fireplaces, barbecue pits, brush piles, etc. To avoid spreading fire, do not use blower near leaf or brush fires, fireplaces, barbecue pits, ashtrays, etc.
- Always use the collection bag shoulder strap when vacuuming to avoid loss of control.
- Check air intake openings, elbow tube, and vacuum tubes frequently, always with the unit stopped and the power source disconnected. Keep vents and tubes free of debris which can accumulate and restrict proper air flow. Do not use with any opening blocked, Keep free of dust, lint, hair and anything that may reduce air flow.

CAUTION: To avoid causing damage to the unit, DO NOT attempt to use the variable speed control during vacuum use.

STANDARDS

This product is listed by Underwriters Laboratories, Inc., in accordance with UL Standard 1017.

If situations occur which are not covered in this manual, use care and good judgment. If you need assistance, contact your authorized service dealer or call 1-800-554-6723. Failure to follow all Safety Rules and Precautions can result in serious injury.

SAVE THESE INSTRUCTIONS

ASSEMBLY

⚠ WARNING: Stop the unit and disconnect from the power source before opening the inlet cover or attempting to insert or remove the inlet restrictor, blower tube, or vacuum tubes. The motor must be stopped and the impeller blades no longer turning to avoid serious injury from the rotating blades.

⚠ WARNING: If received assembled, ensure your unit is properly assembled and all fasteners are secure.

- A standard screwdriver is required for assembly.

BLOWER ASSEMBLY

NOTE: Assembly instructions for using your unit as a vacuum follow this section.

Attaching the blower tube

If you have already assembled your unit for use as a vacuum, refer to the section **HOW TO CONVERT UNIT FROM VACUUM USE TO BLOWER USE**.

To attach blower tube:

1. Align the grooves on the blower tube with the grooves on the blower outlet.
2. Push the blower tube onto the blower outlet until it snaps into place (tube is secured by red tube release button).
3. To remove the blower tube, press the tube release button while pulling on tube.

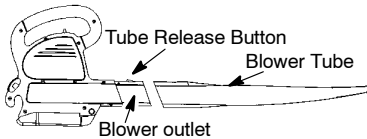

VACUUM ASSEMBLY

NOTE: Assembly instructions for using your unit as a blower are explained in the previous section.

If you have already assembled your unit for use as a blower, remove the blower tube.

CAUTION: To avoid causing damage to the unit, DO NOT attempt to use the variable speed control during vacuum use.

Remove the inlet restrictor

An inlet restrictor is used when using your unit as a blower. This restrictor is not used during vacuum use and must be removed during assembly for vacuum use.

NOTE: Be sure to keep the inlet restrictor for using your unit as a blower.

1. Ensure unit is stopped and extension cord is unplugged.
2. Open the inlet cover by inserting the tip of a screwdriver into the latch area on the blower unit. Gently tilt handle of screwdriver toward the front of the unit to release the latch while pulling up on the vacuum inlet cover with your other hand.

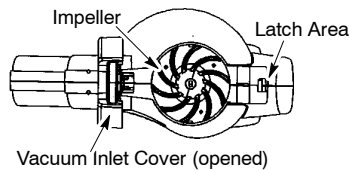
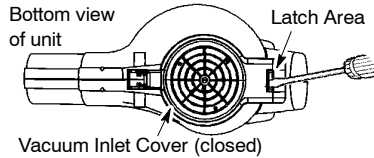

3. Turn the inlet restrictor counterclockwise and remove it from the unit. Do not close the inlet door. You will next attach the vacuum tubes.

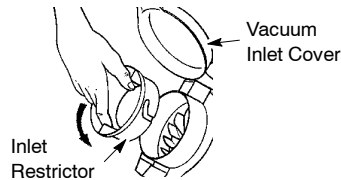

Attaching the vacuum tubes

There are 2 vacuum tubes, an upper tube and a lower tube. The upper tube has a vacuum assist handle attached to one end and is cut straight on both ends. The upper tube attaches to the blower unit. The lower tube has an angled end that you point toward the ground during vacuum use. The lower tube attaches to the upper tube.

1. Ensure unit is stopped and extension cord is unplugged.
2. While holding inlet cover open, place the hooks of the vacuum assist handle on the retaining posts of the unit.
3. Raise the tube until it is secured to the blower unit by the red inlet cover latch.

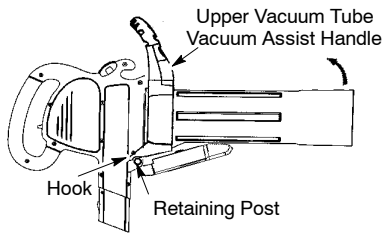

- To attach the lower vacuum tube to the upper vacuum tube, first align the arrows on the two tubes. Then, press the two tubes together until the lower tube is securely seated in the upper tube (about 3 inches).

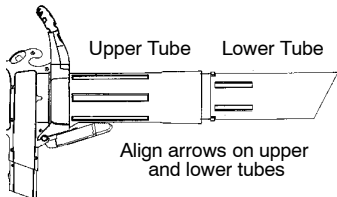

COLLECTION BAG ASSEMBLY

- Open the zipper on the collection bag and insert the elbow tube.
- Push the small end of the elbow tube through the small opening in the bag.

NOTE: Make sure edge of the small opening is flush against the flared area of the elbow tube and the hole for the tube release button is on top.

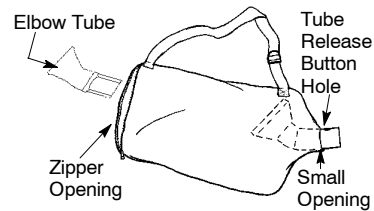

- Close the zipper on the bag. Make sure the zipper is closed completely.
- Align the grooves on the elbow tube with the grooves on the blower outlet.
- Push the elbow tube onto the blower outlet until it snaps into place (elbow tube is secured by red tube release button).

ADJUSTING THE SHOULDER STRAP ON THE COLLECTION BAG

- Carefully loop the shoulder strap through the buckle as shown in the illustration below.

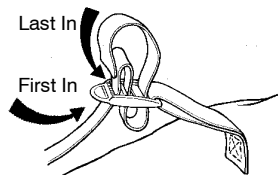

- Position the unit on your right-hand side, blower outlet and bag pointing toward the rear. Hold the unit in an upright position with the lower vacuum tube on the ground to support it.
- Place the shoulder strap over your head and onto your left shoulder.
- Adjust the strap to allow a free flow of air from the blower. If the collection bag is kinked, the unit will not operate properly.

NOTE: The strap is designed to position the collection bag on your shoulder without kinks. The strap is not intended to support the weight of the unit.



HOW TO CONVERT UNIT FROM VACUUM USE TO BLOWER USE

- Stop unit and unplug the extension cord.
- Remove the vacuum tubes by inserting the tip of a screwdriver into the latch area on the vacuum assist handle. Gently tilt handle of screwdriver toward the front of the unit to release the latch while pulling up on the vacuum assist handle with your other hand.

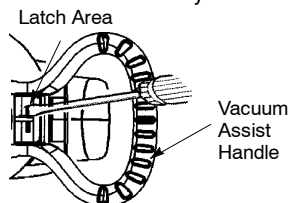

- Install the inlet restrictor that was removed when assembling for vacuum use.

NOTE: If you are unable to locate the inlet restrictor, the unit will still operate. This restrictor improves the blower function.

4. Remove the collection bag.
5. Close the inlet cover and make sure it is latched closed.
6. Re-install the blower tube. Refer to ATTACHING THE BLOWER TUBE for instructions on how to attach this item.

SELECT AN EXTENSION CORD

Use only a 120 A.C. voltage supply as shown on nameplate of the unit to power your blower.

The extension cord used to reach the power source must be:

- Specifically marked as suitable for outdoor use. The cord must be marked with the suffix "W-A" (in Canada "W").
- Heavy enough to carry full current from the power source to the unit. Otherwise, loss of power and overheating can occur causing damage to unit. Refer to table for minimum wire gauge recommendations. The cord must be marked with the proper wire gauge. (Appropriate extension cords are available.) Do not use multiple cords.
- In good condition. Cord insulation must be intact with no cracks or deterioration. Plug connectors must be undamaged. DO NOT use multiple cords.

MINIMUM WIRE GAUGE RECOMMENDATIONS			
VOLTS	25 FT.	50 FT.	100 FT.
120	16 A.W.G.*	16 A.W.G.*	14 A.W.G.*

*American Wire Gauge

Secure the extension cord to the unit by threading the cord through the cord retainer (see illustration). Insert the cord receptacle into the recessed plug.

CAUTION: Failure to use cord retainer could result in damage to the unit, extension cord, or both.

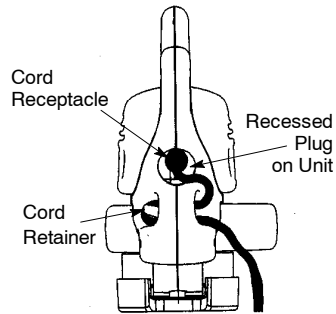

USING YOUR UNIT

KNOW YOUR ELECTRIC BLOWER

READ THIS INSTRUCTION MANUAL AND SAFETY RULES BEFORE OPERATING YOUR UNIT. Compare the illustrations to your unit to familiarize yourself with the location of the various controls and adjustments. Save this manual for future reference.

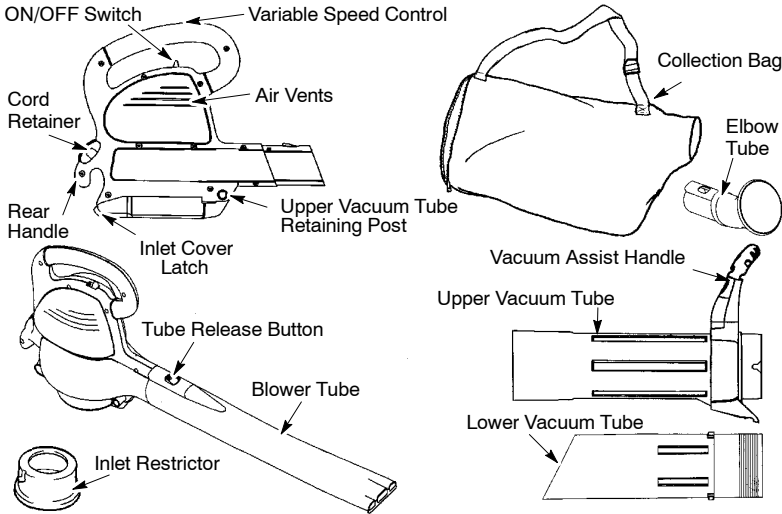

ON/OFF SWITCH

The ON/OFF SWITCH is used to activate the motor.

INLET COVER LATCH

The INLET COVER LATCH is used to open and close the inlet cover and to secure the upper vacuum tube to the blower unit.

BLOWER TUBE

The BLOWER TUBE is designed to direct the flow of air.

INLET RESTRICTOR

The INLET RESTRICTOR improves the blower function.

TUBE RELEASE BUTTON

The TUBE RELEASE BUTTON secures the blower tube or elbow tube to the blower unit during operation. Also, pressing the tube release button allows removal of the blower tube or elbow tube.

VARIABLE SPEED CONTROL

The VARIABLE SPEED CONTROL is designed to allow an increase or decrease in motor speed as necessary during blower use only. To avoid causing damage to the unit, DO NOT attempt to use the variable speed control during vacuum use.

WARNING: You MUST make sure the tubes are secure before using the unit.

WARNING: Do not use the unit without the tubes or collection bag properly attached to avoid flying debris and/or impeller contact which can cause serious injury. Always wear eye protection to prevent rocks or debris from being blown or ricocheting into the eyes and face which can result in blindness or serious injury.

STOPPING YOUR UNIT

To stop your unit, slide the ON/OFF switch to the OFF position.

SWITCH POSITIONS

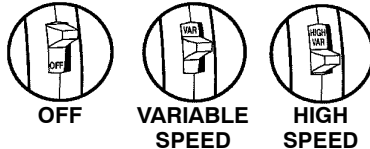

STARTING YOUR UNIT

Your unit has two run positions, HIGH (high speed) and VAR (variable speed). Slide the switch to one of these positions to turn on the unit.

NOTE: The variable speed control will not function with the switch in the HIGH (high speed) position.

With the switch in the VAR (variable speed) position, the motor speed can be increased by moving the control toward the + position or decreased by moving the control toward the - position.

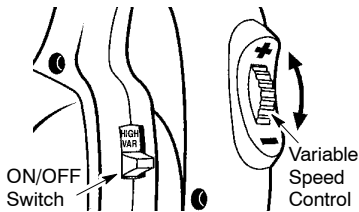

CAUTION: To avoid causing damage to the unit, DO NOT attempt to use the variable speed control during vacuum use.

OPERATING POSITION

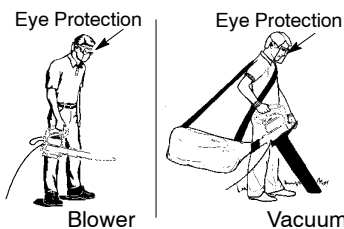

USING YOUR UNIT AS A BLOWER

WARNING: Inspect the area before using the unit. Remove all debris and hard objects such as rocks, glass, wire, etc., that can ricochet, be thrown, or otherwise cause injury or damage during operation.

Use your unit as a blower for:

- Sweeping debris or grass clippings from driveways, sidewalks, patios, etc.

- Blowing grass clippings, straw, or leaves into piles, or removing debris from corners, around joints, or between bricks.

Direct air flow by directing the blower tube down or to one side. Always work away from solid objects such as walks, large stones, vehicles, and fences. Clean corners by starting in corners and moving outward. This will help prevent an accumulation of debris which could fly into your face.

Be careful when working near plants.

The force of the air could damage tender plants.

USING YOUR UNIT AS A VACUUM

WARNING: Do not vacuum stones, gravel, metal, broken glass, etc., to avoid severe damage to the impeller. To avoid the possibility of electrical shock, do not attempt to vacuum water or other liquids.

Use your unit as a vacuum to pick up dry material such as leaves, grass, small twigs, and bits of paper.

- For best results during vacuum use, operate your unit at high speed.

CAUTION: To avoid causing damage to the unit, DO NOT attempt to use the variable speed control during vacuum use.

- Move slowly back and forth over the material as you vacuum. Avoid forcing the unit into a pile of debris as this can clog the unit.
- Keep the vacuum tube about an inch above the ground for best results.

WARNING: If the unit becomes clogged, stop the unit and unplug the extension cord. Wait until the impeller has completely stopped turning, then remove the vacuum tubes. Carefully reach into the vacuum opening and clear out the clogged debris.

MAINTENANCE

WARNING: Disconnect power source before performing maintenance.

GENERAL RECOMMENDATIONS

The warranty on this unit does not cover items that have been subjected to operator abuse or negligence. To receive full value from the warranty, the operator must maintain unit as instructed in this manual. Various adjustments will need to be made periodically to properly maintain your unit.

BEFORE EACH USE CHECK FOR LOOSE FASTENERS AND PARTS

- Inlet Cover
- Blower Tube
- Vacuum Tubes
- Collection Bag

CHECK FOR DAMAGED OR WORN PARTS

Contact your authorized service dealer for replacement of damaged or worn parts.

- ON/OFF Switch - Ensure switch functions properly by moving the switch to the OFF position. Make sure motor stops; then restart motor and continue.
- Inlet Cover - Discontinue use of unit if inlet cover fails to latch properly or if it is damaged in any way.

AFTER EACH USE

INSPECT AND CLEAN UNIT & LABELS

- Stop unit and unplug extension cord.
- After each use, inspect complete unit for loose or damaged parts. Clean the unit using a damp cloth.
- Wipe off unit with a clean dry cloth.

CLEAN COLLECTION BAG

IMPORTANT: THE COLLECTION BAG MUST BE PROPERLY EMPTIED.

- You must properly empty and maintain the collection bag to avoid deterioration and obstruction of air flow.
- Remove the collection bag from the unit and empty after each use. Do not store bag without emptying the bag of all contents (grass, leaves, etc.).
- Wash the bag once a year. Remove the bag from the blower and turn the bag inside out. Wash the bag with a water hose. Allow the bag to hang and dry completely before you reuse the bag.

SERVICE

HOW TO REMOVE AN OBJECT FROM THE AIR INTAKE

⚠ WARNING: Stop the unit and disconnect from the power source before opening the inlet cover. The motor must be stopped and the impeller blades no longer turning to avoid serious injury from the rotating blades.

1. While holding the inlet cover open, remove the vacuum tubes. The inlet cover must be held open through all remaining steps.
2. Carefully reach into the vacuum opening and clear out the air intake area. Clear all debris from impeller.
3. Inspect the impeller for cracks. If cracked or damaged, do not use the unit. Have parts replaced by your authorized service dealer. Do not attempt to replace them yourself.

STORAGE

⚠ WARNING: Perform the following steps after each use:

- Stop unit and disconnect from the power source.
- Allow motor to cool before storing or transporting.
- Store unit with all guards in place. Position unit so that any sharp object cannot accidentally cause injury.
- Store unit unplugged, well out of the reach of children.

SEASONAL STORAGE

Prepare unit for storage at the end of the season or if it will not be used for 30 days or more.

If your blower is to be stored for a period of time:

- Stop unit and disconnect from the power source.
- Clean the entire unit before lengthy storage.
- Open inlet cover and clean any dirt, grass, or debris that has collected. Inspect the blower and all tubes. Close and make sure the cover is latched.
- Clean air vents and air inlet of debris.
- Store your unit and extension cord in a well ventilated area and covered, if possible, to prevent dust and dirt accumulation. Do not cover with plastic. Plastic cannot breathe and may cause condensation and eventual rust or corrosion.
- Check entire unit for loose screws. Replace any damaged, worn, or broken parts.

TROUBLESHOOTING TABLE

⚠ WARNING: Always stop unit and disconnect from the power source before performing all of the recommended remedies below except remedies that require unit to be operating.

SYMPTOM	CAUSE	REMEDY
Unit fails to operate.	1. Switch in the OFF position. 2. Extension cord disconnected. 3. Circuit breaker tripped, or fuse blown. 4. Mechanical failure	1. Slide switch to HIGH or VAR position. 2. Reconnect extension cord. 3. Reset circuit breaker or fuse. 4. Contact your authorized service dealer.
Unit vibrates abnormally.	1. Mechanical failure	1. Contact your authorized service dealer.
Impeller will not turn freely.	1. Debris in air intake area. 2. Mechanical failure.	1. Clean unit. Remove any debris. 2. Contact your authorized service dealer.

LIMITED WARRANTY

WEED EATER warrants to the original purchaser that each new **WEED EATER** brand electric or cordless product is free from defects in material and workmanship and agrees to repair or replace under this warranty any defective **WEED EATER** brand electric or cordless product within two (2) years from the original date of purchase.

If your **WEED EATER** brand electric or cordless product should fail within the limited warranty period, return it, complete, prepaid, with proof of purchase, to the dealer from whom it was purchased for repair or replacement at the option of **WEED EATER**.

This warranty is not transferable and does not cover damage or liability caused by improper handling, improper maintenance or the use of accessories and/or attachments not specifically recommended by **WEED EATER** for this tool. Additionally, this warranty does not cover parts that will wear and require replacement with reasonable use during the warranty period. This warranty does not cover predelivery setup or normal adjustments explained in the instruction manual.

THIS WARRANTY GIVES YOU SPECIFIC LEGAL RIGHTS, AND YOU MAY HAVE OTHER RIGHTS WHICH VARY FROM STATE TO STATE.

NO CLAIMS FOR CONSEQUENTIAL OR OTHER DAMAGES WILL BE ALLOWED, AND THERE ARE NO OTHER EXPRESS WARRANTIES EXCEPT THOSE EXPRESSLY STIPULATED HEREIN.

SOME STATES DO NOT ALLOW LIMITATIONS ON HOW LONG AN IMPLIED WARRANTY LASTS OR THE EXCLUSION OR LIMITATIONS OF INCIDENTAL OR CONSEQUENTIAL DAMAGES, SO THE ABOVE LIMITATIONS OR EXCLUSION MAY NOT APPLY TO YOU.

The policy of **WEED EATER** is to continuously improve its products. Therefore, **WEED EATER** reserves the right to change, modify, or discontinue models, designs, specifications, and accessories of all products at any time without notice or obligation to any purchaser.